

# C36i+

## User Manual





# WARNING

## ALWAYS FOLLOW SAFETY PRECAUTIONS

**NEVER** climb, sit or stand on the cart.



**ONLY ADULTS** should move the cart.



To reduce risk of electric shock **ONLY** use indoors.

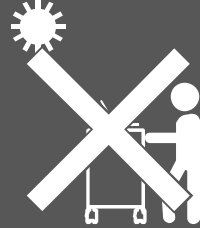

### CAUTION

This cart is intended for use only with loading as indicated. Use with loads greater than indicated may result in instability causing possible injury.

≤ 44.1lbs (20kg)

≤ 72lbs (32.66kg)

≤ 72lbs (32.66kg)

≤ 72lbs (32.66kg)

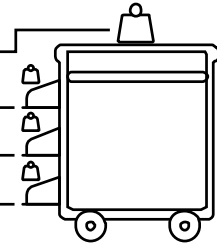

Please place the devices from the bottom to top shelf to avoid the tilting.

- Death or serious injury may occur when children climb on audio and/or video equipment furniture. A remote control or toys placed on the furnishing may encourage a child to climb on the furnishing and as a result the furnishing may tip over on to the child.
- Relocating audio and/or video equipment to furniture not specifically designed to support audio and/or video equipment may result in death or serious injury due to the furnishing collapsing or over turning onto a child.

## CAUTION!

- **DO NOT** allow anyone to sit, stand or climb on the cart.
- **DO NOT** lift the cart.
- **DO NOT** block the ventilation holes used for air circulation.
- **DO NOT** overload objects on the cart shelves. (work platform maximum loading = 20kg / 44.1lbs; each pull-out shelf maximum loading = 32.66kg / 72lbs).
- **DO NOT** put any devices that the weight is over the maximum loading weight on top of cart.
- When moving the cart, **DO NOT** put any devices (ex: TV, Monitor, Documents camera...etc.) on top of cart.
- No TV/monitor is to be used on top of cart.
- Before moving the cart, disconnect the power from the wall outlet.
- While moving the cart, make sure the power cord is secured and tightly wrapped.

## **FCC NOTICE (Class A)**



This device complies with Part 15 of the FCC Rules. Operation is subject to the following two conditions: (1) this device may not cause harmful interference, and (2) this device must accept any interference received, including interference that may cause undesired operation.

### **Federal Communications Commission Statement**

NOTE: This equipment has been tested and found to comply with the limits for a Class A digital device, pursuant to part 15 of the FCC Rules. These limits are designed to provide reasonable protection against harmful interference when the equipment is operated in a commercial environment. This equipment generates, uses, and can radiate radiofrequency energy and, if not installed and used in accordance with the instruction manual, may cause harmful interference to radio communications. Operation of this equipment in a residential area is likely to cause harmful interference in which case the user will be required to correct the interference at his own expense.

FCC Caution: Any changes or modifications not expressly approved by the party responsible for compliance could void the user's authority to operate this equipment.

This device complies with part 15 of the FCC Rules.

Operation is subject to the following two conditions:

- (1) This device may not cause harmful interference, and
- (2) This device must accept any interference received, including interference that may cause undesired operation.

**Warning:** This is a class A product. In a domestic environment this product may cause radio interference in which case the user may be required to take adequate measures

### **European Community Compliance Statement (Class A)**



This product is herewith confirmed to comply with the requirements set out in the Council Directives on the Approximation of the laws of the Member States relating to Electromagnetic Compatibility Directive 2014/30/EU.

**Warning:** This is a class A product. In a domestic environment this product may cause radio interference in which case the user may be required to take adequate measures.

## **DISCLAIMER**

No warranty or representation, either expressed or implied, is made with respect to the contents of this documentation, its quality, performance, merchantability, or fitness for a particular purpose. Information presented in this documentation has been carefully checked for reliability; however, no responsibility is assumed for inaccuracies. The information contained in this documentation is subject to change without notice.

In no event will AVer Information Inc. be liable for direct, indirect, special, incidental, or consequential damages arising out of the use or inability to use this product or documentation, even if advised of the possibility of such damages.

## **TRADEMARKS**

“AVer” is a trademark owned by AVer Information Inc. Other trademarks used herein for description purpose only belong to each of their companies.

## **COPYRIGHT**

©2018 AVer Information Inc. All rights reserved.

All rights of this object belong to AVer Information Inc. Reproduced or transmitted in any form or by any means without the prior written permission of AVer Information Inc. is prohibited. All information or specifications are subject to change without prior notice.



The mark of Crossed-out wheeled bin indicates that this product must not be disposed of with your other household waste. Instead, you need to dispose of the waste equipment by handing it over to a designated collection point for the recycling of waste electrical and electronic equipment. For more information about where to drop off your waste equipment for recycling, please contact your household waste disposal service or the shop where you purchased the product.

# Contents

Package Contents .....	1
Dimensions .....	1
Diagram .....	2
LED Indicators .....	3
Secure the Cart.....	3
Door Lock .....	4
Cable Management .....	5
Charging Cart .....	7
Intelligent Timer .....	8
Firmware.....	8
Troubleshooting .....	9
Specifications.....	10
Service and Warranty .....	11

# Package Contents

The following items are included in the package. Please check if each item is available before using.

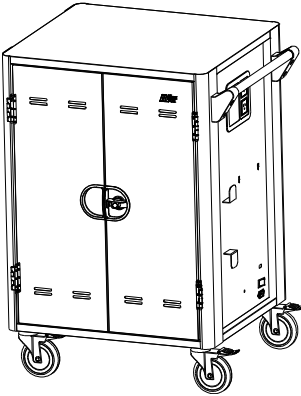

**C36i+ Cart**



**User Manual**



**Door key x4**



**Power Cord\***

\* Power cord type may vary as they are country dependent.

# Dimensions

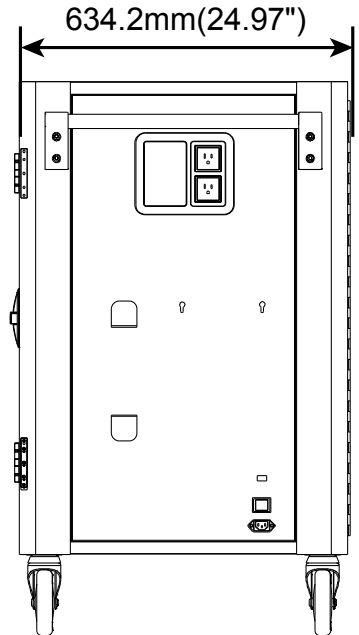
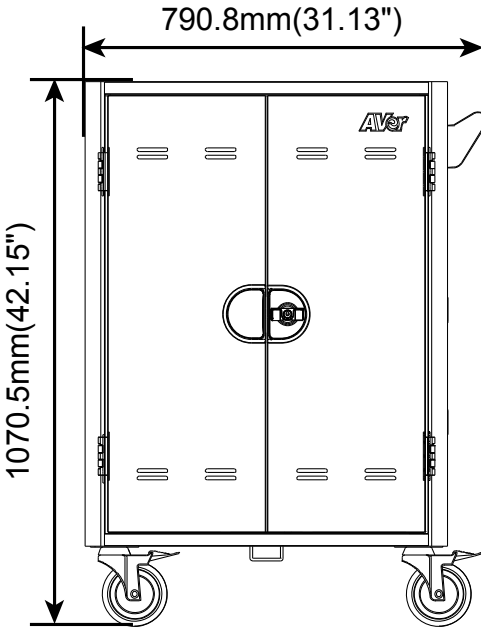

# Diagram

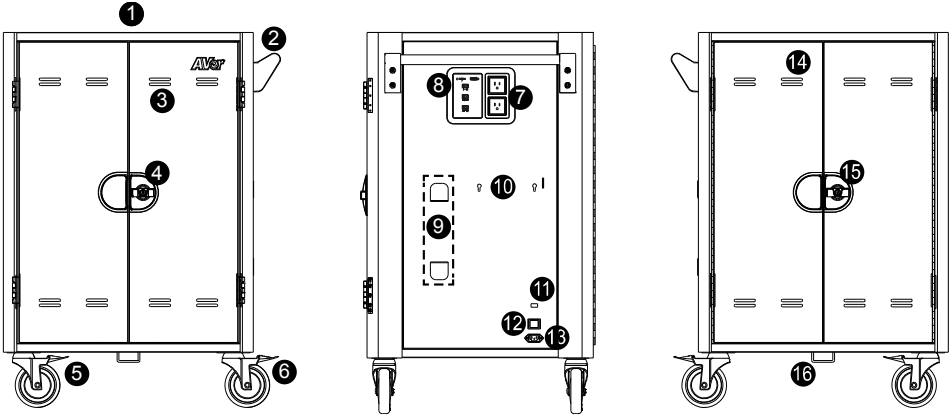

Front	Side	Back
1. Work platform	7. Auxiliary outlets*	14. Ventilation holes
2. Handle	8. LED panel	15. Door lock
3. Ventilation holes	9. Power cable wrap brackets	16. Security hook
4. Door lock	10. Mounting points for Access point holder(optional)**	
5. 5" locking caster	11. USB firmware upgrade port	
6. 5" directional lock caster*	12. Power switch	
*Keep the cart rolling in the fixed direction	13. Power inlet	

\* Auxiliary outlet and power inlet type may vary as they are country dependent.

\*\* Please make sure the Access point holder is balanced and installed securely to cart.



# LED Indicators

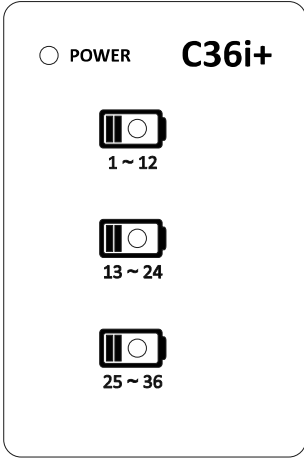

LED	Status
Power x1	<ol style="list-style-type: none"> <li><b>Solid Green:</b> ON</li> <li><b>Flashing Orange:</b> Current Overload</li> <li><b>Flashing Red:</b> Abnormal Failure (Contact Support)</li> <li><b>Flashing Green and Orange:</b> Current Overload (AUX is turn off).</li> </ol>
Device Status x3	<ol style="list-style-type: none"> <li><b>OFF:</b> No Charging</li> <li><b>Solid Blue:</b> Charging</li> </ol>

# Secure the Cart

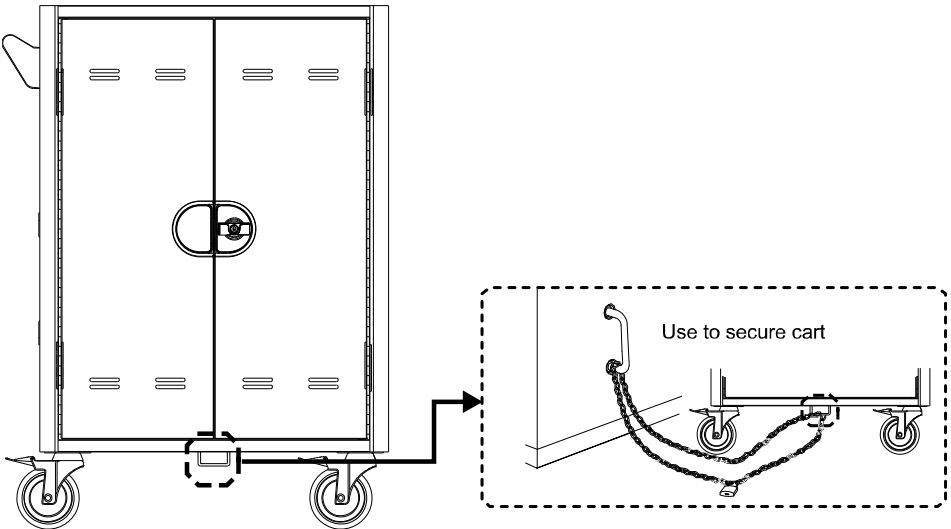

# Door Lock

## ■ Unlock the door

- ① Use key to unlock the door.

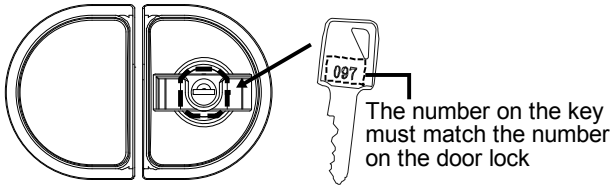

- ② Turn the door lock to vertical position to open the door.

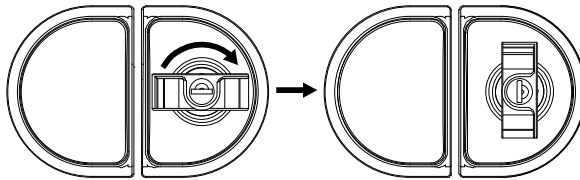

## ■ Lock the door

To lock the door, close the door and turn the door lock back to horizontal position.

Then, use the key to lock the door.

For more security, use padlock to double secure the door.

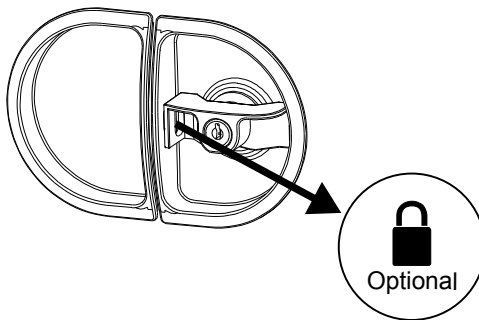

**[Note]** The shackle dimension of front and back doors are limited to Ø8mm (0.31”).

# Cable Management

## [Note]

1. It is recommended to use cable ties (optional) to secure and manage cables.
2. It is recommended to allocate 2 persons for efficient device cabling.

## Back

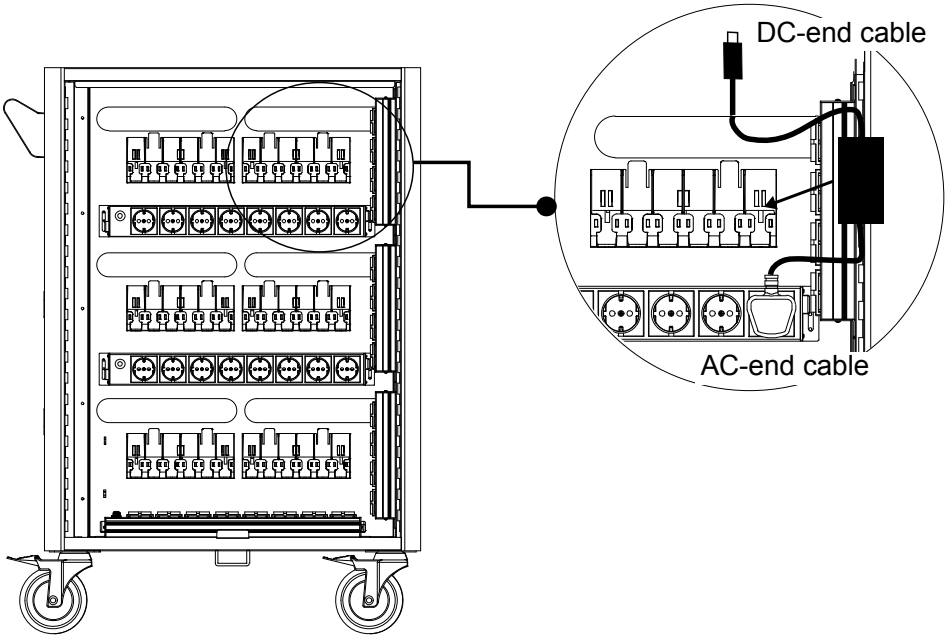

1. Open the rear door.
2. Place the power adapter in to the individual adapter compartment.
3. Pass the DC-end of the adapter cable to the front of the cart through the space provided.
4. Plug-in the AC-end power cord to the corresponding power AC socket.
5. Bundle the cable and secure it with cable tie or zip-tie (not supplied).

## Front

1. Open front double doors
2. Pull out each shelf until it is fully extended.

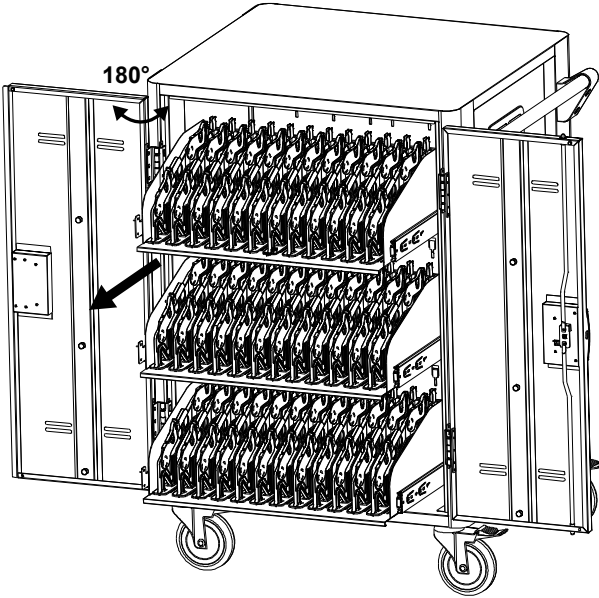

3. Release the cable clamp by pulling locking feature (A).
4. Route the adaptor DC-end cable. Along with the V-shape routing groove.

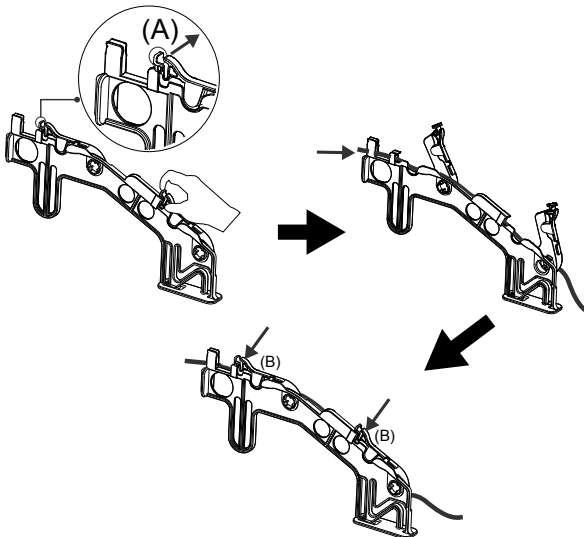

5. Snap the locking piece(B) to firmly secure the DC-end cable.
6. Place the mobile device into the bay.
7. Plug in the DC-connector to the mobile device.

## Charging Cart

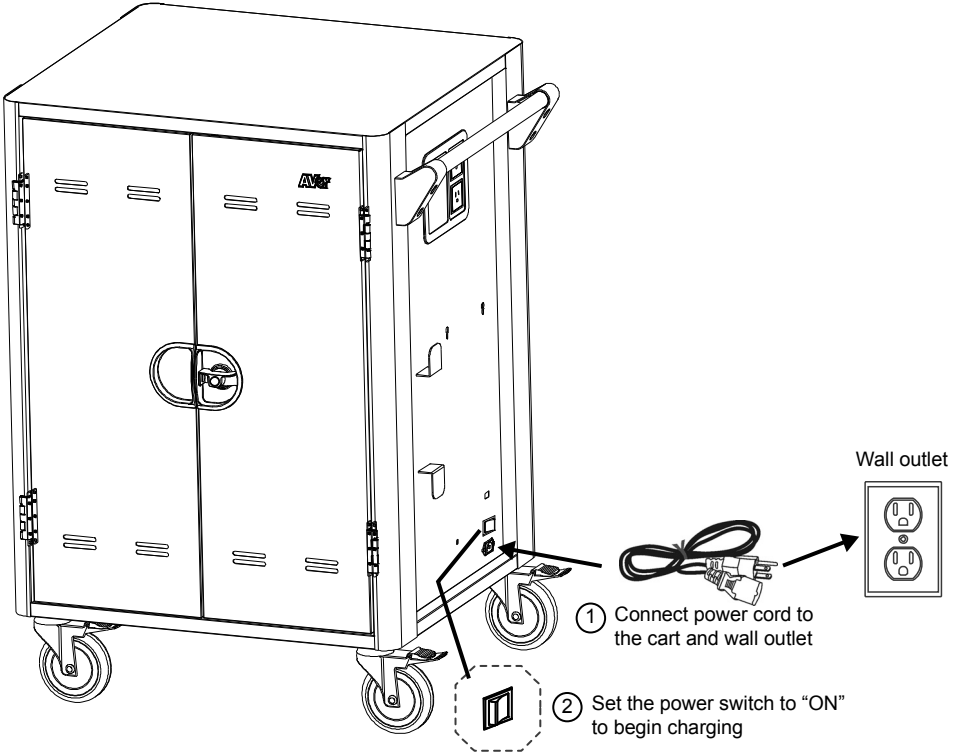

### [Note]

1. Set the power switch to the **OFF** position before plugging the cart to wall outlet.
- 2.\* Auxiliary outlet and power inlet type may vary as they are country dependent.

# Intelligent Timer

36 bays for C36i+ are divided into 3 zones (12 bays for each zone).

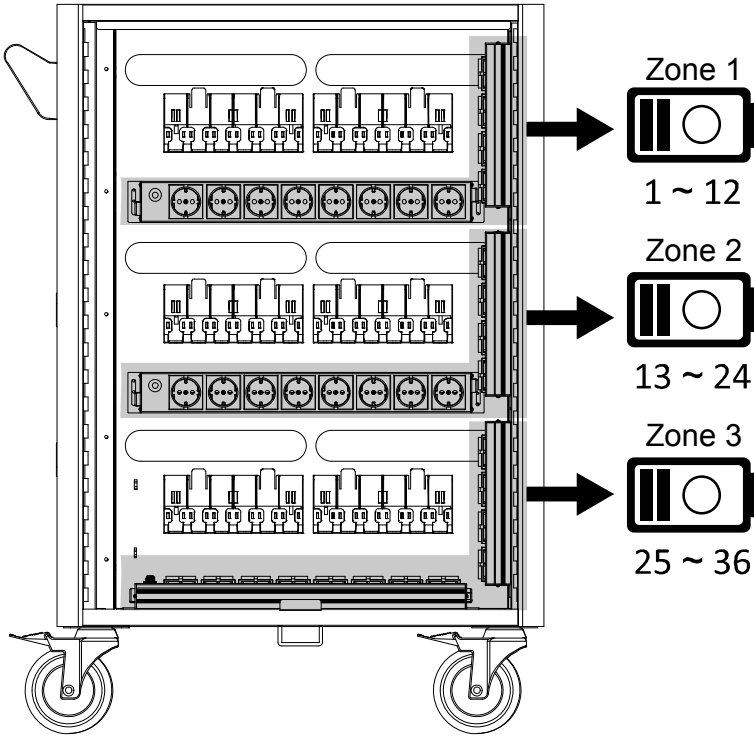

## Firmware

Firmware can be upgraded with typical USB thumb drive via with external Type-A USB port. Please follow the steps below to upgrade your firmware:

1. Prior to updating, make sure the USB thumb-drive is formatted to FAT or FAT32 filesystem.
2. Copy the firmware binary file ( \*.bin ) to USB thumb-drive.
3. Turn **OFF** C36i+ and then insert the USB thumb-drive.
4. Turn **ON** C36i+ and the firmware upgrade will update automatically. The Power LED will cycle through the following display **GREEN** → **RED** → **ORANGE**.

**[Note]** Device status LED are **ON** (Solid Blue) by following sequence **Zone 1** → **Zone 2** → **Zone 3** during the upgrading.

5. Once the firmware upgrade is completed, the Power LED will still display **GREEN → RED → ORANGE** in cycle, and the device charging status LED will always turn **ON** (Solid Blue).
6. Turn **OFF** C36i+, remove the USB thumb-drive.

**[Note]**

C36i+ supports USB thumb-drive for the following criteria:

1. FAT or FAT32 filesystem (need to format if necessary).
2. 32GB capacity maximum.
3. USB 2.0 high speed interface.

## **Troubleshooting**

**Q: Why are all of my devices plugged in but not charging?**

- A: 1. Make sure power cords are undamaged.
2. Make sure power cords are firmly inserted into the available socket with stable current.
  3. Make sure the power plug and current consumption are compliant with your country specification standards.

**Q: My cart's main power cord or cart components are damaged. Are they covered under warranty?**

A: We provide a 10 year warranty on the cart and tray, and 5 years warranty on the electrical components.

**Q: How do I know if my devices will exceed more than the allotted current?**

A: Have a qualified electrician verify the current consumption of your devices. Perform the test with devices installed and batteries discharged.

**Q: When I plug in the device it trips the circuit breaker. What is wrong?**

A: You may have other equipment or appliances sharing the same circuit that is causing a circuit overload. Have a qualified electrician check that adequate power is available in the circuit.

# Specifications

Model	C36i+
Capacity	36 (three shelves, 12 bays per shelf)
Supported Devices	Mobile devices up to 15"
AUX Outlets	2
LEDs Status Indicators	Power LED: Green Status LED (x3): Solid Blue: Charging
Charging Type	AC Adaptive Intelligent Charging
Power Specification	AC IN: 220~240V, 50/60Hz, 8A Power Strip: 220~240V, 50/60Hz, 8A Outlet: 220~240V, 50/60Hz, 8A
Security	Front Doors: 3-point locking mechanism with padlock hole Rear Doors: 3-point locking mechanism with padlock hole <b>[Note]</b> Padlock is not included in the package
Casters	Four 5" casters: two are lockable and two directional lock
Pull-out Shelves	Yes
Intelligent Charging	Yes
Top Surface (work platform)	20kg (44.1lbs)
Shelf Support Weight(ea.)	32.66kg (72lbs)
Adapter Shelves(ea.)	3kg(6.6lbs)
Access point holder Loading	3kg
Working Temperature	0°~30°C
Working RH%	10%~90%
Storage Temperature	-40°C~60°C
Storage RH%	5%~95%



<b>Model</b>	C36i+
<b>Warranty</b>	10 years cart and tray 5 years electrical components
<b>Cart Dimensions (W x D x H)</b>	790.8 (W) x 634.2 (D) x 1070.5 (H) mm 31.13"(W) x 24.97"(D) x 42.15"(H)
<b>Slot Dimensions (W x D x H)</b>	36(W)x 380(D) x 260(H) mm 1.42"(W) x 14.96"(D) x 10.24"(H)
<b>Weight without Devices</b>	80 Kg (176.38lbs)

## Service and Warranty

All of our products come with a quality and safety assurance.

Please visit AVer Global support site: <http://www.aver.com/>